

Cascade Sidesifters

PROMATCH® PARTS PROGRAM

PROMATCH®

Introduction 1

Quick-Mount™ Sideshifters

Installation 2
Options and Accessories..... 3

Sideshifters

Cascade 5
Cat Lift Trucks..... 6
Clark..... 8
Crown 9
Hamech 10
Hyster 11
Linde..... 13
Mitsubishi Forklift Trucks 14
Nissan..... 16
Raymond 18
TCM..... 19
Toyota 20
TUSK..... 21
Yale 22
Doosan/Hyundai/Landoll/Schaeff/Tailift 24

Increase Productivity with Cascade Sideshifters

Cascade Sideshifters, now available through the Promatch® parts program, reduce handling time and improve maneuverability by permitting lateral repositioning of the forks without moving the truck. By enabling the forks to easily shift from side to side, Sideshifters provide a high return on investment by offering the following benefits:

Less Damage to Pallets, Product and Racks

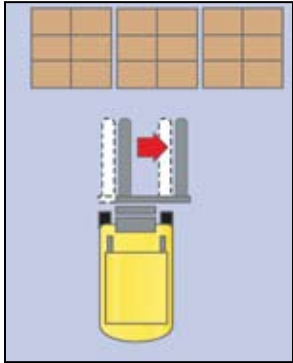

With a Sideshifter, operators can easily position forks for correct pallet entry, decreasing the chance of shoving forks into an improperly aligned pallet—a major cause of pallet damage. Likewise, the potential for product damage is significantly reduced. Since accurate fork positioning speeds movement, damage to racks is also reduced.

Improved Warehouse Stacking

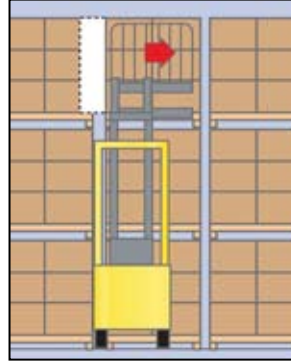

Sideshifters simplify tight stacking and encourage neat, well-aligned stacks. That means better use of warehouse space.

Faster Transit-Vehicle Loading and Unloading

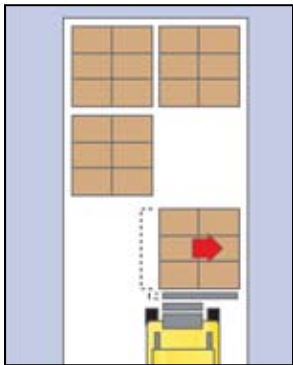

A Sideshifter permits the operator to spot loads against sidewalls or in tight stacks quickly and accurately. No more “jockeying” to get the exact entry position. Sideshifters also help operators breakout and place loads in difficult locations such as behind rail car doors and van side doors.

Better Maneuverability in Tight Quarters

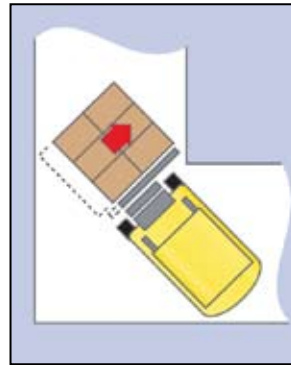

Sideshifters ease maneuvering in places like narrow aisles, rail cars and truck vans. The ability to shift the forks just a few inches frequently means completing the turn without repositioning the truck.

Faster Cycle Times

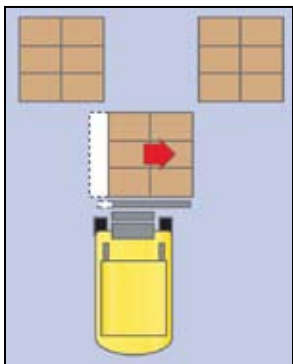

Operators can make faster approaches with a minimum of maneuvering to spot the load. That means faster cycle times.

Reduced Truck Wear and Tear

Since trucks maneuver less, especially in transit vehicles and on dock boards, there’s less wear and tear on truck components.

Sideshifters are available to match nearly every type of forklift truck backrest and are shipped fully assembled for immediate installation with no welding required. Capacities are available up to 15,000 lbs.

Installation Kit

Each kit contains the necessary hoses and fittings to connect a standard sideshifter to the hose terminal on the forklift carriage.

Model	Cascade No.	p/n
55F, 65F, 100F	205826	A000021227
120D, 150D, 165D	209555	A000032399
120D, 150D, 165D	223987	A000032400*

*For high pressure, up to 4,000 PSI.
For ORFS kits please contact Promatch® dealer support.

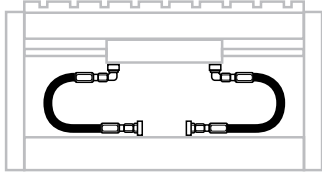

Notes

- Freight prepaid on single shipments of five or more sideshifters.
- Cascade recommends that all sideshifters be equipped with load backrests meeting OSHA requirements.
- Cascade Load Backrests comply with OSHA requirements.
- Use your truck's standard backrest. Carriage widths and bolt patterns are compatible with a wide range of OEM forklift models.
- **CAUTION:** Cascade Quick-Mount™ Sideshifters are shipped without load backrests unless a backrest is ordered separately.
- Can be installed in less than one hour (not including hydraulic supply).
- No welding, drilling or tapping required.
- Attachment capacity should be matched to the derated truck capacity with the attachment installed for most efficient application.
- For wider sideshifters on narrow carriages, please contact Promatch® dealer support.
- The following F-Series Sideshifters are pre-drilled to accept Revolution Fork Positioning mechanism: 55F/65F - Sideshifters up to 51.2" in carriage width and 100F - Sideshifters up to 55.1" in carriage width.

Mounting Class Information

Mounting Class	Truck Capacity @ 24" Load Center
II	2,000 to 5,500 lbs
III	6,000 to 10,000 lbs
IV	10,001 to 17,500 lbs



IMPORTANT: OSHA or state regulations may require the installation of backrests. We suggest that you check your use of sideshifters against these requirements. Attachments are structurally designed to be mounted on forklift trucks for lifting applications only. They are not to be used to support the forklift for transport or any other purposes.

Hydraulic Flow and Pressure

Model	Minimum Pressure PSI	Maximum Pressure PSI	Number of Functions	Min-Rec-Max Function 1 gpm
55F/65F	2,200	3,500	1	1 2 3
100F	2,200	3,500	1	1 4 5
120D	2,200	3,500	1	1 5 8
150D/165D	2,200	3,500	1	1 6 12

Hydraulic Functions

Model	Hydraulic Functions	Truck Auxiliary Valves Required
SSS	1	1

Load Backrest Types

- A: End hole patterns
- B: Face hole patterns
- C: Face hole patterns with counterbore

Load Backrest—Cascade Models

- For Quick-Mount™ Sideshifters
- Factory install backrest on sideshifter for additional cost.
Please contact Promatch dealer support for pricing information.
- For OEM load backrests please contact Promatch dealer support.
- Backrest heights of 36", 48" and 60" are available with short lead times for all catalog Class II and III sideshifters.
- Custom load backrests can be made to your specifications.
Please contact Promatch dealer support for more information.

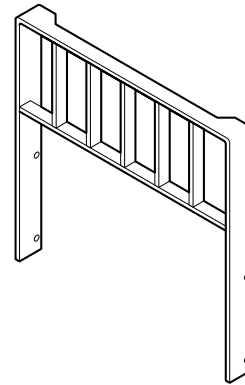

Model	Sideshift Carriage Width	Cascade No.	p/n	Backrest Height	Weight	
					lbs	kg
55F	31"	684769	A000032405*	36"	50	23
55F	31"	684770	A000032406*	48"	75	34
55F	31"	684771	A000032407*	60"	80	36
55F	37"	684772	A000032408*	36"	55	25
55F	37"	684773	A000032409*	48"	83	38
55F	37"	684774	A000032410*	60"	90	41
55F	41"	684775	A000032411*	36"	60	27
55F	41"	684776	A000032412*	48"	90	41
55F	41"	684777	A000032413*	60"	100	45
55F	49"	684778	A000032414*	36"	70	32
55F	49"	684779	A000032415*	48"	99	45
55F	49"	684780	A000032416*	60"	110	50
55F	61"	684781	A000032417*	36"	80	36
55F	61"	684782	A000032418*	48"	105	48
55F	61"	684783	A000032419*	60"	130	59

Model	Sideshift Carriage Width	Cascade No.	p/n	Backrest Height	Weight	
					lbs	kg
65F and 100F	37"	684784	A000032420*	36"	55	25
65F and 100F	37"	684785	A000032421*	48"	78	35
65F and 100F	37"	684786	A000032422*	60"	90	41
65F and 100F	41"	684787	A000032423*	36"	60	27
65F and 100F	41"	684788	A000032424*	48"	85	39
65F and 100F	41"	684789	A000032425*	60"	90	41
65F and 100F	49"	684790	A000032426*	36"	65	30
65F and 100F	49"	684791	A000032427*	48"	92	42
65F and 100F	49"	684792	A000032428*	60"	105	48
65F and 100F	61"	684793	A000032429*	36"	75	34
65F and 100F	61"	684794	A000032430*	48"	100	45
65F and 100F	61"	684795	A000032431*	60"	125	57
65F and 100F	72"	360279	A000032432*	48"	121	55
120D/150D/165D	49"	686341	A000032433**	48"	110	50
120D/150D/165D	49"	686342	A000032434**	60"	134	61
120D/150D/165D	61"	686343	A000032435**	48"	137	62
120D/150D/165D	61"	686344	A000032436**	60"	168	76
120D/150D/165D	72"	220471	A000032437**	48"	162	74

*End-drilled bolt pattern. **Front drilled bolt pattern.

Bolt-On Pallet Protector

Model	Cascade No.	p/n
55F	220688	A000032402
65F	6057694	A000032403
100F	6072258	A000032404

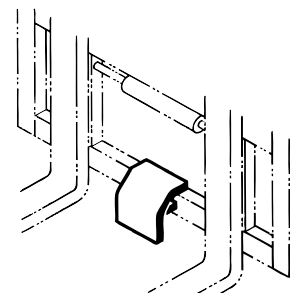

Quick-Disconnect Mounting Kit (Factory Install Only)

Mounting Class	p/n
II	A000032438
III	A000032439
IV	A000032440

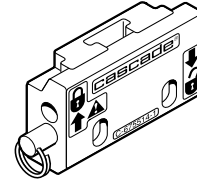

Quick-Disconnect Hi-Termination Kit

p/n - A000032401 (Cascade No. - 205823)

Supplies necessary tubes and fittings to complete hydraulic installation of sideshifter used in conjunction with Quick-Disconnect Couplers and Sideshifter Installation Kits.

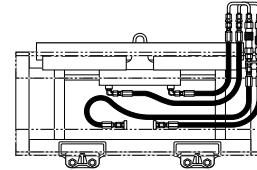

Hydraulic Components Guard

Please contact Promatch dealer support for installation details. Hydraulic Components Guard protects forklift truck and sideshifter hydraulic components.

Model	p/n
55F	A000032441
65F and 100F	A000032442

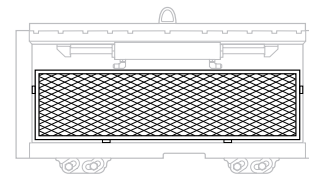

Bronze Upper Bearings

Bronze Upper Bearings are used in highly abrasive and contaminated environments.

Model	p/n
55F, 65F, 100F	A000032443
120D, 150D, 165D	A000032444

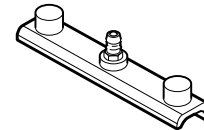

Heavy Duty/Extended Load Center and Cold Storage Package

Upper and lower bronze bearings and lower hooks.

Model	p/n
55F	A000032445
65F	A000032446
100F	A000032447

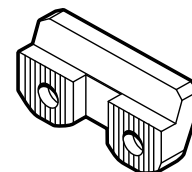

Cascade F-Series and D-Series

Capacity @ 24" (600 mm) Load Center		Carriage Width w/o Load Backrest	Cascade No.	p/n	Mtg. Class	Total Sideshift Available	Min. Truck Carriage Width	Weight		Effective Thickness	Horizontal Center of Gravity	Vertical Center of Gravity	# Backrest Holes/Side	Load Backrest Type
lbs	kg							lbs	kg					
5,500	2,500	31.0"	55F-SSS-A056	A000032169	II	8"	28.9"	100	46	2.3"	1.1"	9.3"	2	A
5,500	2,500	37.0"	55F-SSS-A051	A000032166	II	8"	35.2"	112	51	2.3"	1.1"	9.2"	2	A
5,500	2,500	41.0"	55F-SSS-A052	A000032167	II	8"	35.2"	120	55	2.3"	1.1"	9.1"	2	A
5,500	2,500	49.0"	55F-SSS-A054	A000032168	II	8"	40.9"	146	67	2.3"	1.1"	8.9"	2	A
5,500	2,500	61.0"	55F-SSS-A057	A000032170	II	8"	51.9"	203	93	2.3"	1.0"	8.5"	2	A
6,500	3,000	37.0"	65F-SSS-B051	A000032247	III	8"	34.3"	141	65	2.5"	1.1"	11.6"	2	A
6,500	3,000	40.9"	65F-SSS-B052	A000032248	III	8"	36.8"	152	70	2.5"	1.1"	11.7"	2	A
6,500	3,000	49.0"	65F-SSS-B053	A000032249	III	8"	40.7"	172	79	2.5"	1.1"	11.8"	2	A
6,500	3,000	61.0"	65F-SSS-B054	A000032250	III	8"	47.8"	234	107	2.5"	1.1"	11.5"	2	A
10,000	4,600	40.9"	100F-SSS-B051	A000032297	III	8"	36.8"	253	115	3.0"	1.3"	12.4"	2	A
10,000	4,600	49.0"	100F-SSS-B052	A000032298	III	8"	41.9"	288	131	3.0"	1.3"	12.4"	2	A
10,000	4,600	61.0"	100F-SSS-B053	A000032299	III	8"	48.8"	381	173	3.0"	1.3"	12.2"	2	A
10,000	4,600	72.0"	100F-SSS-B054	A000032300	III	8"	65.7"	486	221	3.0"	1.3"	12.0"	2	A
12,000	5,450	49.0"	120D-SSS-C051	A000032341	IV	8"	42.1"	350	159	3.0"	1.3"	15.1"	2	C
12,000	5,450	61.0"	120D-SSS-C052	A000032342	IV	8"	56.6"	400	182	3.0"	1.3"	15.1"	2	C
12,000	5,450	72.0"	120D-SSS-C055	A000032343	IV	8"	62.9"	495	225	3.0"	1.3"	15.1"	2	C
15,000	6,810	49.0"	150D-SSS-C051	A000032370	IV	12"	46.0"	510	232	3.3"	1.7"	17.4"	2	C
15,000	6,810	61.0"	150D-SSS-C053	A000032371	IV	12"	48.0"	610	277	3.3"	1.7"	17.4"	2	C
15,000	6,810	72.0"	150D-SSS-C055	A000032372	IV	12"	60.0"	705	320	3.3"	1.7"	17.4"	2	C
16,500	7,490	49.0"	165D-SSS-C051	A000032392	IV	12"	49.0"	510	232	3.3"	1.7"	17.4"	2	C
16,500	7,490	61.0"	165D-SSS-C053	A000032393	IV	12"	61.0"	610	277	3.3"	1.7"	17.4"	2	C
16,500	7,490	72.0"	165D-SSS-C055	A000032394	IV	12"	72.0"	705	320	3.3"	1.7"	17.4"	2	C

F-Series

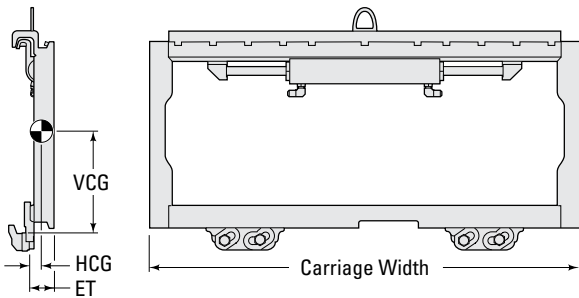

Load Backrest Types

- A: End hole patterns
- B: Face hole patterns
- C: Face hole patterns with counterbore

Installation Kit

Model	Cascade No.	p/n
55F, 65F, 100F	205826	A000021227
120D, 150D, 165D	209555	A000032399
120D, 150D, 165D	223987	A000032400*

*For high pressure, up to 4,000 PSI.

D-Series

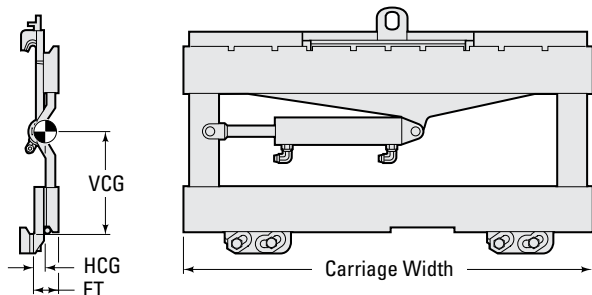

Cat Lift Trucks F-Series

Capacity @ 24" (600 mm) Load Center		Carriage Width w/o Load Backrest	Cascade No.	p/n	Mtg. Class	Total Sideshift Available	Min. Truck Carriage Width	Weight		Effective Thickness	Horizontal Center of Gravity	Vertical Center of Gravity	# Backrest Holes/ Side	Load Backrest Type
lbs	kg							lbs	kg					
5,500	2,500	32.3"	55F-SSS-A224	A000032223*	II	8"	28.9"	100	46	2.3"	1.1"	9.3"	2	A
5,500	2,500	32.3"	55F-SSS-A093	A000032199	II	8"	28.9"	103	47	2.3"	1.1"	9.3"	4	A
5,500	2,500	36.2"	55F-SSS-A222	A000032221*	II	8"	30.9"	110	50	2.3"	1.1"	9.2"	2	A
5,500	2,500	36.2"	55F-SSS-A091	A000032197	II	8"	30.9"	110	50	2.3"	1.1"	9.2"	4	A
5,500	2,500	38.3"	55F-SSS-A035	A000032156*	II	8"	35.2"	115	53	2.3"	1.1"	9.2"	2	B
5,500	2,500	39.4"	55F-SSS-A223	A000032222*	II	8"	35.2"	117	54	2.3"	1.1"	9.2"	2	A
5,500	2,500	39.4"	55F-SSS-A092	A000032198	II	8"	35.2"	117	54	2.3"	1.1"	9.2"	4	A
5,500	2,500	43.4"	55F-SSS-A037	A000032157	II	8"	38.4"	125	57	2.3"	1.1"	9.1"	2	B
5,500	2,500	55.1"	55F-SSS-A094	A000032200	II	8"	45.1"	177	81	2.3"	1.0"	8.6"	4	A
5,500	2,500	55.1"	55F-SSS-A225	A000032224*	II	8"	45.1"	177	81	2.3"	1.0"	8.6"	2	A
6,500	3,000	37.8"	65F-SSS-B091	A000032268	III	8"	34.3"	144	66	2.5"	1.1"	11.7"	4	A
6,500	3,000	37.8"	65F-SSS-B159	A000032277	III	8"	34.3"	144	66	2.5"	1.1"	11.7"	2	A
6,500	3,000	37.8"	65F-SSS-B160	A000032278*	III	8"	34.3"	144	66	2.5"	1.1"	11.7"	2	A
6,500	3,000	39.4"	65F-SSS-B092	A000032269	III	8"	34.3"	148	68	2.5"	1.1"	11.7"	4	A
6,500	3,000	39.4"	65F-SSS-B161	A000032279*	III	8"	34.3"	148	68	2.5"	1.1"	11.7"	2	A
6,500	3,000	41.5"	65F-SSS-B033	A000032240	III	8"	36.8"	154	70	2.5"	1.1"	11.7"	2	B
6,500	3,000	43.9"	65F-SSS-B034	A000032241	III	8"	36.8"	159	73	2.5"	1.1"	11.7"	2	B
6,500	3,000	59.1"	65F-SSS-B090	A000032267	III	8"	47.8"	229	105	2.5"	1.1"	11.5"	4	A
6,500	3,000	59.1"	65F-SSS-B162	A000032280	III	8"	47.8"	229	105	2.5"	1.1"	11.5"	2	A
10,000	4,600	39.4"	100F-SSS-B200	A000032318*	III	8"	34.8"	244	111	3.0"	1.3"	12.4"	2	A
10,000	4,600	44.3"	100F-SSS-B201	A000032319*	III	8"	39.8"	268	122	3.0"	1.3"	12.4"	2	B
10,000	4,600	46.9"	100F-SSS-B203	A000032321*	III	8"	39.8"	279	127	3.0"	1.3"	12.4"	2	A
10,000	4,600	46.9"	100F-SSS-B093	A000032311	III	8"	39.8"	279	127	3.0"	1.3"	12.4"	4	A
10,000	4,600	47.8"	100F-SSS-B032	A000032292	III	8"	40.7"	335	153	3.0"	1.3"	12.4"	2	B
10,000	4,600	59.1"	100F-SSS-B204	A000032322*	III	8"	48.8"	372	169	3.0"	1.3"	12.2"	2	A
10,000	4,600	59.1"	100F-SSS-B202	A000032320	III	8"	48.8"	372	169	3.0"	1.3"	12.2"	2	A
10,000	4,600	60.0"	100F-SSS-B207	A000032324	III	8"	48.8"	376	171	3.0"	1.3"	12.2"	2	B
10,000	4,600	70.9"	100F-SSS-B205	A000032323	III	8"	65.7"	480	218	3.0"	1.3"	12.0"	2	A

*Compatible with current OEM production.

F-Series

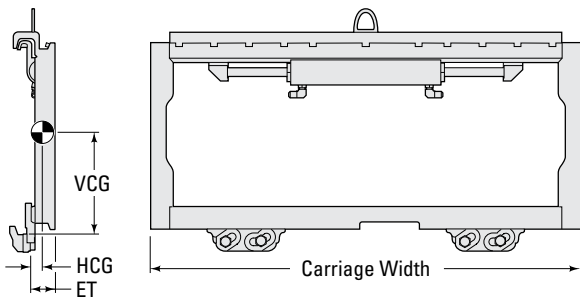

Load Backrest Types

- A: End hole patterns
- B: Face hole patterns
- C: Face hole patterns with counterbore

Installation Kit

Model	Cascade No.	p/n
55F, 65F, 100F	205826	A000021227

Cat Lift Trucks D-Series

Capacity @ 24" (600 mm) Load Center		Carriage Width w/o Load Backrest	Cascade No.	p/n	Mtg. Class	Total Sideshift Available	Min. Truck Carriage Width	Weight		Effective Thickness	Horizontal Center of Gravity	Vertical Center of Gravity	# Backrest Holes/ Side	Load Backrest Type
lbs	kg							lbs	kg					
12,000	5,450	44.3"	120D-SSS-C125	A000032351*	IV	8"	42.1"	306	139	3.0"	1.3"	15.1"	2	B
12,000	5,450	46.9"	120D-SSS-C122	A000032349	IV	8"	42.1"	339	154	3.0"	1.3"	15.1"	4	A
12,000	5,450	46.9"	120D-SSS-C127	A000032353*	IV	8"	42.1"	339	154	3.0"	1.3"	15.1"	2	A
12,000	5,450	59.1"	120D-SSS-C128	A000032354*	IV	8"	56.6"	392	178	3.0"	1.3"	15.1"	2	A
12,000	5,450	59.1"	120D-SSS-C123	A000032350	IV	8"	56.6"	392	178	3.0"	1.3"	15.1"	4	A
12,000	5,450	60.0"	120D-SSS-C126	A000032352	IV	8"	56.6"	385	175	3.0"	1.3"	15.1"	2	B
12,000	5,450	70.9"	120D-SSS-C129	A000032355*	IV	8"	62.6"	491	223	3.0"	1.3"	15.1"	2	A
15,000	6,810	44.3"	150D-SSS-C035	A000032368	IV	8"	42.1"	460	209	3.3"	1.7"	17.4"	2	B
15,000	6,810	46.9"	150D-SSS-C017	A000032363	IV	12"	46.0"	491	223	3.3"	1.7"	17.4"	4	A
15,000	6,810	47.8"	150D-SSS-C031	A000032367	IV	12"	46.0"	506	230	3.3"	1.7"	17.4"	2	B
15,000	6,810	51.0"	150D-SSS-C110	A000032388*	IV	12"	48.0"	546	248	3.3"	1.7"	17.4"	2	B
15,000	6,810	59.1"	150D-SSS-C108	A000032386	IV	12"	48.0"	580	263	3.3"	1.7"	17.4"	4	A
15,000	6,810	70.9"	150D-SSS-C109	A000032387	IV	12"	60.0"	704	320	3.3"	1.7"	17.4"	4	A

*Compatible with current OEM production.

D-Series

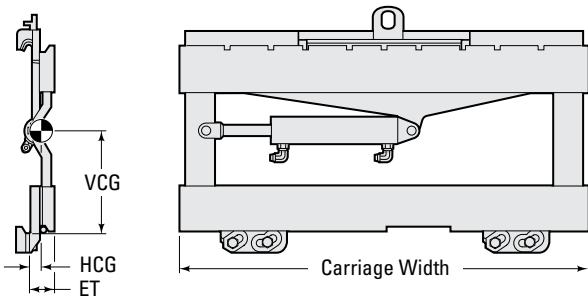

Load Backrest Types

- A: End hole patterns
- B: Face hole patterns
- C: Face hole patterns with counterbore

Installation Kit

Model	Cascade No.	p/n
55F, 65F, 100F	205826	A000021227
120D, 150D, 165D	209555	A000032399
120D, 150D, 165D	223987	A000032400*

*For high pressure, up to 4,000 PSI.

Clark F-Series and D-Series

Capacity @ 24" (600 mm) Load Center		Carriage Width w/o Load Backrest	Cascade No.	p/n	Mtg. Class	Total Sideshift Available	Min. Truck Carriage Width	Weight		Effective Thickness	Horizontal Center of Gravity	Vertical Center of Gravity	# Backrest Holes/ Side	Load Backrest Type
lbs	kg							lbs	kg					
5,500	2,500	31.0"	55F-SSS-A056	A000032169	II	8"	28.9"	100	46	2.3"	1.1"	9.3"	2	A
5,500	2,500	37.0"	55F-SSS-A051	A000032166*	II	8"	35.2"	112	51	2.3"	1.1"	9.2"	2	A
5,500	2,500	41.0"	55F-SSS-A052	A000032167*	II	8"	35.2"	120	55	2.3"	1.1"	9.1"	2	A
5,500	2,500	49.0"	55F-SSS-A054	A000032168	II	8"	40.9"	146	67	2.3"	1.1"	8.9"	2	A
5,500	2,500	61.0"	55F-SSS-A057	A000032170	II	8"	51.9"	203	93	2.3"	1.0"	8.5"	2	A
6,500	3,000	37.0"	65F-SSS-B051	A000032247	III	8"	34.3"	141	65	2.5"	1.1"	11.6"	2	A
6,500	3,000	40.9"	65F-SSS-B052	A000032248*	III	8"	36.8"	152	70	2.5"	1.1"	11.7"	2	A
6,500	3,000	44.9"	65F-SSS-B056	A000032251	III	8"	36.8"	161	74	2.5"	1.1"	11.7"	2	A
6,500	3,000	49.0"	65F-SSS-B053	A000032249	III	8"	40.7"	172	79	2.5"	1.1"	11.8"	2	A
6,500	3,000	61.0"	65F-SSS-B054	A000032250	III	8"	47.8"	234	107	2.5"	1.1"	11.5"	2	A
10,000	4,600	40.9"	100F-SSS-B051	A000032297	III	8"	36.8"	253	115	3.0"	1.3"	12.4"	2	A
10,000	4,600	49.0"	100F-SSS-B052	A000032298*	III	8"	41.9"	288	131	3.0"	1.3"	12.4"	2	A
10,000	4,600	61.0"	100F-SSS-B053	A000032299	III	8"	48.8"	381	173	3.0"	1.3"	12.2"	2	A
10,000	4,600	72.0"	100F-SSS-B054	A000032300	III	8"	65.7"	486	221	3.0"	1.3"	12.0"	2	A
12,000	5,450	49.0"	120D-SSS-C001	A000032328	IV	8"	42.1"	350	159	3.0"	1.3"	15.1"	2	C
15,000	6,810	55.0"	150D-SSS-C062	A000032373*	IV	12"	48.0"	561	255	3.3"	1.7"	17.4"	2	A

*Compatible with current OEM production.

F-Series

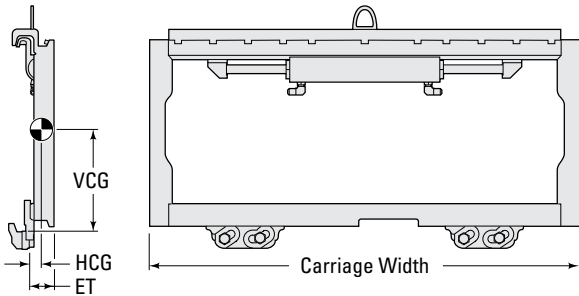

Load Backrest Types

- A: End hole patterns
- B: Face hole patterns
- C: Face hole patterns with counterbore

Installation Kit

Model	Cascade No.	p/n
55F, 65F, 100F	205826	A000021227
120D, 150D, 165D	209555	A000032399
120D, 150D, 165D	223987	A000032400*

*For high pressure, up to 4,000 PSI.

These kits only work in conjunction with a Clark Conversion Fitting.

D-Series

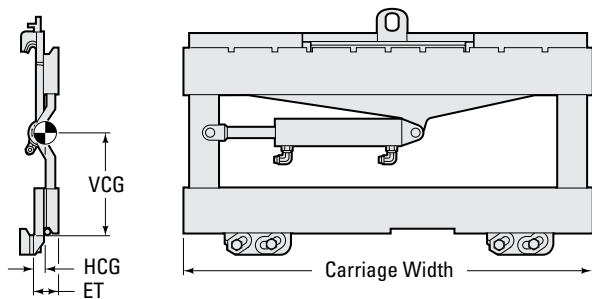

Crown F-Series

Capacity @ 24" (600 mm) Load Center		Carriage Width w/o Load Backrest	Cascade No.	p/n	Mtg. Class	Total Sideshift Available	Min. Truck Carriage Width	Weight		Effective Thickness	Horizontal Center of Gravity	Vertical Center of Gravity	# Backrest Holes/Side	Load Backrest Type
lbs	kg							lbs	kg					
5,500	2,500	31.5"	55F-SSS-A061	A000032174	II	8"	28.9"	101	46	2.3"	1.1"	9.3"	2	A
5,500	2,500	31.9"	55F-SSS-A180	A000032213	II	8"	28.9"	103	47	2.3"	1.1"	9.2"	2	A
5,500	2,500	34.3"	55F-SSS-A059	A000032172	II	8"	30.9"	107	49	2.3"	1.1"	9.3"	2	C
5,500	2,500	34.5"	55F-SSS-A062	A000032175*	II	8"	30.8"	107	49	2.3"	1.1"	9.3"	2	A
5,500	2,500	37.7"	55F-SSS-A060	A000032173	II	8"	35.2"	113	51	2.3"	1.1"	9.2"	2	C
5,500	2,500	38.0"	55F-SSS-A063	A000032176*	II	8"	35.2"	114	52	2.3"	1.1"	9.2"	2	A
5,500	2,500	43.7"	55F-SSS-A058	A000032171	II	8"	38.4"	125	57	2.3"	1.1"	9.1"	2	C
5,500	2,500	44.0"	55F-SSS-A064	A000032177	II	8"	38.4"	126	28	2.3"	1.1"	9.1"	2	A
6,500	3,000	38.0"	65F-SSS-B061	A000032252	III	8"	34.3"	145	66	2.5"	1.0"	11.7"	2	A
6,500	3,000	44.0"	65F-SSS-B062	A000032253	III	8"	36.8"	160	73	2.5"	1.1"	11.7"	2	A

*Compatible with current OEM production.

F-Series

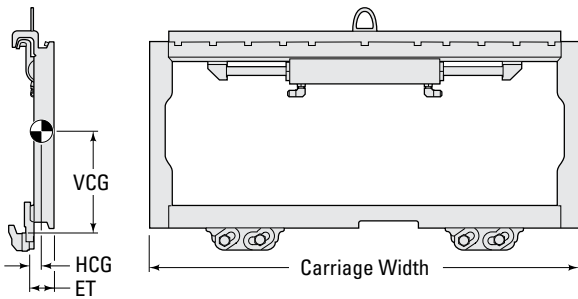

Load Backrest Types

- A: End hole patterns
- B: Face hole patterns
- C: Face hole patterns with counterbore

Installation Kit

Model	Cascade No.	p/n
55F, 65F, 100F	205826	A000021227

Hamech F-Series and D-Series

Capacity @ 24" (600 mm) Load Center		Carriage Width w/o Load Backrest	Cascade No.	p/n	Mtg. Class	Total Sideshift Available	Min. Truck Carriage Width	Weight		Effective Thickness	Horizontal Center of Gravity	Vertical Center of Gravity	# Backrest Holes/ Side	Load Backrest Type
lbs	kg							lbs	kg					
5,500	2,500	37.0"	55F-SSS-A051	A000032166	II	8"	35.2"	112	51	2.3"	1.1"	9.2"	2	A
5,500	2,500	41.0"	55F-SSS-A052	A000032167	II	8"	35.2"	120	55	2.3"	1.1"	9.1"	2	A
5,500	2,500	49.0"	55F-SSS-A054	A000032168	II	8"	40.9"	146	67	2.3"	1.1"	8.9"	2	A
5,500	2,500	61.0"	55F-SSS-A057	A000032170	II	8"	51.9"	203	93	2.3"	1.0"	8.5"	2	A
5,500	2,500	53.0"	55F-SSS-A079	A000032187	II	8"	40.9"	172	79	2.3"	1.0"	8.5"	2	A
6,500	3,000	37.0"	65F-SSS-B051	A000032247	III	8"	34.3"	141	65	2.5"	1.1"	11.6"	2	A
6,500	3,000	40.9"	65F-SSS-B052	A000032248	III	8"	36.8"	152	70	2.5"	1.1"	11.7"	2	A
6,500	3,000	49.0"	65F-SSS-B053	A000032249	III	8"	40.7"	172	79	2.5"	1.1"	11.8"	2	A
6,500	3,000	53.0"	65F-SSS-B078	A000032259	III	8"	40.7"	214	98	2.5"	1.1"	11.4"	2	A
6,500	3,000	61.0"	65F-SSS-B054	A000032250	III	8"	47.8"	234	107	2.5"	1.1"	11.5"	2	A
10,000	4,600	68.1"	100F-SSS-B063	A000032303	III	8"	57.9"	447	203	3.0"	1.3"	12.0"	4	A
12,000	5,450	46.8"	120D-SSS-C067	A000032344	IV	8"	42.1"	338	154	3.0"	1.3"	15.1"	4	A
12,000	5,450	68.1"	120D-SSS-C068	A000032345	IV	8"	62.9"	476	216	3.0"	1.3"	15.1"	4	A
15,000	6,810	59.4"	150D-SSS-C075	A000032376	IV	12"	48.0"	585	265	3.3"	1.7"	17.4"	4	A
15,000	6,810	67.7"	150D-SSS-C098	A000032383	IV	12"	59.0"	680	309	3.3"	1.7"	17.4"	4	A
15,000	6,810	72.0"	150D-SSS-C099	A000032384	IV	12"	60.0"	704	320	3.3"	1.7"	17.4"	4	A
15,000	6,810	91.7"	150D-SSS-C100	A000032385	IV	12"	82.0"	830	377	3.3"	1.7"	17.4"	4	A

F-Series

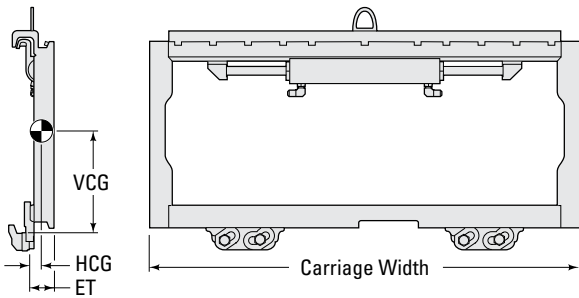

Load Backrest Types

- A: End hole patterns
- B: Face hole patterns
- C: Face hole patterns with counterbore

Installation Kit

Model	Cascade No.	p/n
55F, 65F, 100F	205826	A000021227
120D, 150D, 165D	209555	A000032399
120D, 150D, 165D	223987	A000032400*

*For high pressure, up to 4,000 PSI.

D-Series

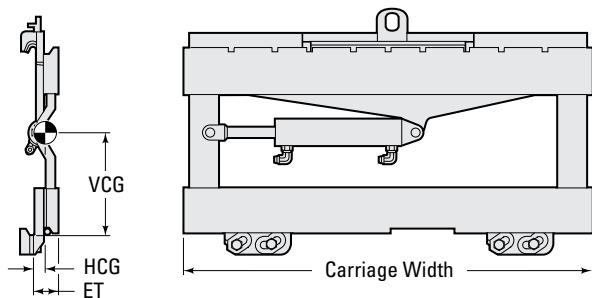

Hyster F-Series and D-Series

Capacity @ 24" (600 mm) Load Center		Carriage Width w/o Load Backrest	Cascade No.	p/n	Mtg. Class	Total Sideshift Available	Min. Truck Carriage Width	Weight		Effective Thickness	Horizontal Center of Gravity	Vertical Center of Gravity	# Backrest Holes/ Side	Load Backrest Type
lbs	kg							lbs	kg					
5,500	2,500	29.0"	55F-SSS-A006	A000032137	II	8"	26.2"	96	44	2.3"	1.1"	9.3"	2	A
5,500	2,500	33.7"	55F-SSS-A007	A000032138	II	8"	28.9"	105	48	2.3"	1.1"	9.2"	2	C
5,500	2,500	35.7"	55F-SSS-A045	A000032164	II	8"	35.2"	109	50	2.3"	1.1"	9.2"	2	C
5,500	2,500	36.0"	55F-SSS-A001	A000032136	II	8"	35.2"	110	50	2.3"	1.1"	9.2"	2	B
5,500	2,500	37.5"	55F-SSS-A028	A000032152	II	8"	35.2"	113	51	2.3"	1.1"	9.2"	2	A
5,500	2,500	38.0"	55F-SSS-A008	A000032139	II	8"	35.2"	114	52	2.3"	1.1"	9.2"	2	B
5,500	2,500	38.5"	55F-SSS-A030	A000032153	II	8"	35.2"	115	53	2.3"	1.1"	9.2"	2	C
5,500	2,500	42.0"	55F-SSS-A009	A000032140	II	8"	38.4"	122	56	2.3"	1.1"	9.2"	2	C
6,500	3,000	38.0"	65F-SSS-B001	A000032229	III	8"	34.3"	145	66	2.5"	1.1"	11.7"	2	B
6,500	3,000	38.5"	65F-SSS-B003	A000032231	III	8"	34.3"	146	47	2.5"	1.1"	11.7"	2	B
6,500	3,000	42.0"	65F-SSS-B002	A000032230	III	8"	36.8"	154	70	2.5"	1.1"	11.7"	2	B
10,000	4,600	42.0"	100F-SSS-B001	A000032281	III	8"	36.8"	257	117	3.0"	1.3"	12.4"	2	B
10,000	4,600	47.3"	100F-SSS-B006	A000032284	III	8"	41.9"	282	128	3.0"	1.3"	12.4"	2	B
10,000	4,600	48.0"	100F-SSS-B002	A000032282	III	8"	41.9"	284	129	3.0"	1.3"	12.4"	2	B
10,000	4,600	53.3"	100F-SSS-B007	A000032285	III	8"	46.7"	312	142	3.0"	1.3"	12.4"	2	B
10,000	4,600	60.0"	100F-SSS-B003	A000032283	III	8"	48.8"	376	171	3.0"	1.3"	12.2"	2	B
12,000	5,450	42.0"	120D-SSS-C021	A000032330	IV	8"	42.1"	319	145	3.0"	1.3"	15.1"	2	B
12,000	5,450	47.3"	120D-SSS-C018	A000032329	IV	8"	42.0"	345	157	3.0"	1.3"	15.1"	2	B
12,000	5,450	48.0"	120D-SSS-C022	A000032331	IV	8"	42.1"	345	157	3.0"	1.3"	15.1"	2	B
12,000	5,450	54.0"	120D-SSS-C023	A000032332	IV	8"	50.9"	370	168	3.0"	1.3"	15.1"	2	B
12,000	5,450	60.0"	120D-SSS-C024	A000032333	IV	8"	56.6"	383	174	3.0"	1.3"	15.1"	2	B
15,000	6,810	42.0"	150D-SSS-C025	A000032365*	IV	8"	42.0"	453	205	3.3"	1.9"	14.7"	2	C
15,000	6,810	42.0"	150D-SSS-C001	A000032356	IV	8"	42.0"	465	211	3.3"	1.7"	17.4"	2	B
15,000	6,810	48.0"	150D-SSS-C024	A000032364*	IV	12"	46.0"	490	222	3.3"	1.9"	14.7"	2	C
15,000	6,810	48.0"	150D-SSS-C002	A000032357	IV	12"	46.0"	506	230	3.3"	1.7"	17.4"	2	B
15,000	6,810	60.0"	150D-SSS-C026	A000032366*	IV	12"	48.0"	564	255	3.3"	1.9"	14.7"	2	C
15,000	6,810	60.0"	150D-SSS-C003	A000032358	IV	12"	48.0"	590	268	3.3"	1.7"	17.4"	2	B
15,000	6,810	78.0"	150D-SSS-0004	A000032359*	IV	12"	78.0"***	781	354	3.4"	1.8"	14.3"	3	A

*Compatible with current OEM production. **If host carriage has no end bars, 72" minimum truck carriage width is available.

F-Series

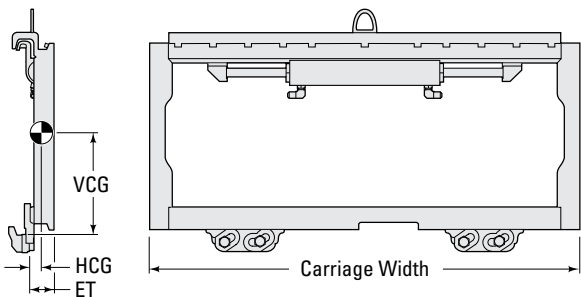

D-Series

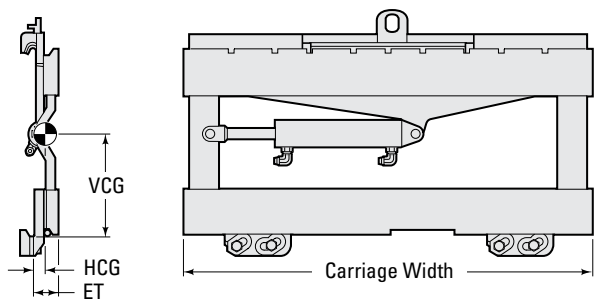

Load Backrest Types

- A: End hole patterns
- B: Face hole patterns
- C: Face hole patterns with counterbore

Installation Kit

Model	Cascade No.	p/n
55F, 65F, 100F	205826	A000021227
120D, 150D, 165D	209555	A000032399
120D, 150D, 165D	223987	A000032400*

*For high pressure, up to 4,000 PSI.

Komatsu F-Series and D-Series

Capacity @ 24" (600 mm) Load Center		Carriage Width w/o Load Backrest	Cascade No.	p/n	Mtg. Class	Total Sideshift Available	Min. Truck Carriage Width	Weight		Effective Thickness	Horizontal Center of Gravity	Vertical Center of Gravity	# Backrest Holes/ Side	Load Backrest Type
lbs	kg							lbs	kg					
5,500	2,500	31.0"	55F-SSS-A056	A000032169	II	8"	28.9"	100	46	2.3"	1.1"	9.3"	2	A
5,500	2,500	37.0"	55F-SSS-A051	A000032166	II	8"	35.2"	112	51	2.3"	1.1"	9.2"	2	A
5,500	2,500	38.2"	55F-SSS-A077	A000032186	II	8"	35.2"	114	52	2.3"	1.1"	9.1"	4	A
5,500	2,500	41.0"	55F-SSS-A052	A000032167	II	8"	35.2"	120	55	2.3"	1.1"	9.1"	2	A
5,500	2,500	49.0"	55F-SSS-A054	A000032168	II	8"	40.9"	146	67	2.3"	1.1"	8.9"	2	A
5,500	2,500	53.0"	55F-SSS-A079	A000032187	II	8"	40.9"	172	79	2.3"	1.0"	8.5"	2	A
5,500	2,500	61.0"	55F-SSS-A057	A000032170	II	8"	51.9"	203	93	2.3"	1.0"	8.5"	2	A
6,500	3,000	37.0"	65F-SSS-B051	A000032247	III	8"	34.3"	141	65	2.5"	1.1"	11.6"	2	A
6,500	3,000	37.8"	65F-SSS-B075	A000032258	III	8"	34.3"	144	66	2.5"	1.1"	11.7"	2	A
6,500	3,000	40.9"	65F-SSS-B052	A000032248	III	8"	36.8"	152	70	2.5"	1.1"	11.7"	2	A
6,500	3,000	41.7"	65F-SSS-B079	A000032260	III	8"	36.8"	154	71	2.5"	1.1"	11.7"	4	A
6,500	3,000	49.0"	65F-SSS-B053	A000032249	III	8"	40.7"	172	79	2.5"	1.1"	11.8"	2	A
6,500	3,000	53.0"	65F-SSS-B078	A000032259	III	8"	40.7"	214	98	2.5"	1.1"	11.4"	2	A
6,500	3,000	61.0"	65F-SSS-B054	A000032250	III	8"	47.8"	234	107	2.5"	1.1"	11.5"	2	A
10,000	4,600	41.7"	100F-SSS-B058	A000032301	III	8"	36.8"	255	116	3.0"	1.3"	12.4"	4	A
10,000	4,600	46.9"	100F-SSS-B061	A000032302	III	8"	39.8"	279	127	3.0"	1.3"	12.4"	4	A
10,000	4,600	68.1"	100F-SSS-B063	A000032303	III	8"	57.9"	447	203	3.0"	1.3"	12.0"	4	A
12,000	5,450	46.8"	120D-SSS-C067	A000032344	IV	8"	42.1"	338	154	3.0"	1.3"	15.1"	4	A
12,000	5,450	68.1"	120D-SSS-C068	A000032345	IV	8"	62.9"	476	216	3.0"	1.3"	15.1"	4	A
15,000	6,810	67.7"	150D-SSS-C098	A000032383	IV	12"	59.0"	680	309	3.3"	1.7"	17.4"	4	A
15,000	6,810	72.0"	150D-SSS-C099	A000032384	IV	12"	60.0"	704	320	3.3"	1.7"	17.4"	4	A
15,000	6,810	91.7"	150D-SSS-C100	A000032385	IV	12"	82.0"	830	377	3.3"	1.7"	17.4"	4	A

F-Series

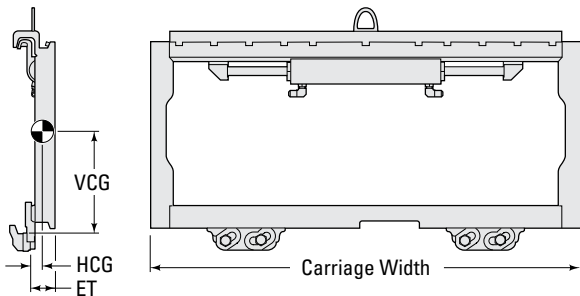

Load Backrest Types

- A: End hole patterns
- B: Face hole patterns
- C: Face hole patterns with counterbore

Installation Kit

Model	Cascade No.	p/n
55F, 65F, 100F	205826	A000021227
120D, 150D, 165D	209555	A000032399
120D, 150D, 165D	223987	A000032400*

*For high pressure, up to 4,000 PSI.

D-Series

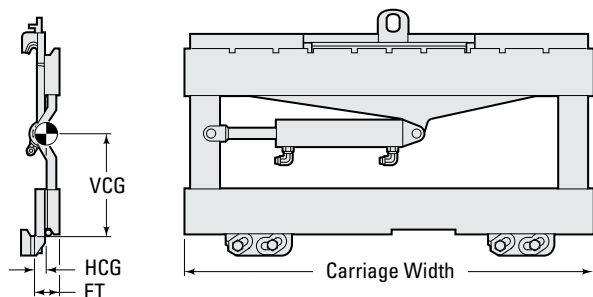

Linde F-Series and D-Series

Capacity @ 24" (600 mm) Load Center		Carriage Width w/o Load Backrest	Cascade No.	p/n	Mtg. Class	Total Sideshift Available	Min. Truck Carriage Width	Weight		Effective Thickness	Horizontal Center of Gravity	Vertical Center of Gravity	# Backrest Holes/ Side	Load Backrest Type
lbs	kg							lbs	kg					
5,500	2,500	38.6"	55F-SSS-A019	A000032146	II	8"	35.2"	115	53	2.3"	1.1"	9.2"	1	C
5,500	2,500	38.6"	55F-SSS-A198	A000032215	II	8"	35.2"	115	53	2.3"	1.1"	9.2"	1	B
5,500	2,500	40.9"	55F-SSS-A196	A000032214	II	8"	35.2"	120	55	2.3"	1.1"	9.1"	1	B
5,500	2,500	40.9"	55F-SSS-A015	A000032144	II	8"	35.2"	120	55	2.3"	1.1"	9.1"	1	B
5,500	2,500	45.3"	55F-SSS-A016	A000032145	II	8"	40.9"	129	59	2.3"	1.1"	9.1"	1	B
5,500	2,500	45.3"	55F-SSS-A199	A000032216*	II	8"	40.9"	129	59	2.3"	1.1"	9.1"	1	B
6,500	3,000	45.3"	65F-SSS-B012	A000032232	III	8"	40.7"	171	78	2.5"	1.1"	11.8"	1	B
6,500	3,000	51.2"	65F-SSS-B014	A000032234	III	8"	40.7"	177	81	2.5"	1.1"	11.8"	1	B
6,500	3,000	63.0"	65F-SSS-B013	A000032233	III	8"	53.9"	277	126	2.5"	1.1"	11.4"	1	B
10,000	4,600	45.3"	100F-SSS-B016	A000032289	III	8"	39.8"	275	125	3.0"	1.3"	12.4"	1	B
10,000	4,600	51.2"	100F-SSS-B013	A000032286	III	8"	46.7"	304	138	3.0"	1.3"	12.4"	1	B
10,000	4,600	53.1"	100F-SSS-B017	A000032290	III	8"	48.0"	312	142	3.0"	1.3"	12.4"	2	B
10,000	4,600	63.0"	100F-SSS-B014	A000032287	III	8"	57.9"	396	180	3.0"	1.3"	12.2"	1	B
10,000	4,600	68.9"	100F-SSS-B015	A000032288	III	8"	65.7"	451	205	3.0"	1.3"	12.2"	2	B
10,000	4,600	78.7"	100F-SSS-B018	A000032291	III	8"	70.5"	515	234	3.0"	1.3"	12.2"	2	B
12,000	5,450	85.8"	120D-SSS-C072	A000032346	IV	8"	76.0"	601	273	3.0"	1.3"	15.1"	2	B
15,000	6,810	70.9"	150D-SSS-C013	A000032360	IV	12"	60.0"	705	320	3.3"	1.8"	14.7"	2	B
15,000	6,810	85.8"	150D-SSS-C014	A000032361	IV	12"	64.5"	787	357	3.3"	1.8"	14.7"	2	B
15,000	6,810	94.5"	150D-SSS-C015	A000032362	IV	12"	70.0"	897	407	3.3"	1.8"	14.7"	2	B
16,500	7,490	70.9"	165D-SSS-C013	A000032389	IV	12"	70.9"	705	320	3.3"	1.8"	14.7"	2	B
16,500	7,490	85.8"	165D-SSS-C014	A000032390	IV	12"	85.8"	787	357	3.3"	1.8"	14.7"	2	B
16,500	7,490	94.5"	165D-SSS-C015	A000032391	IV	12"	94.5"	897	407	3.3"	1.8"	14.7"	2	B

*For 347 Series only.

F-Series

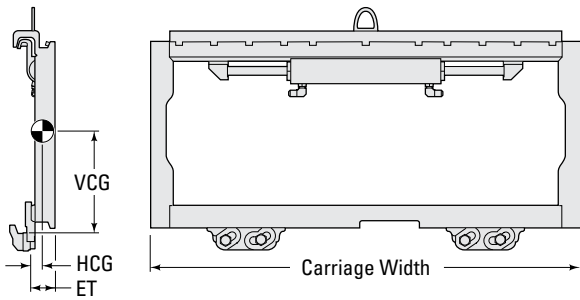

Load Backrest Types

- A: End hole patterns
- B: Face hole patterns
- C: Face hole patterns with counterbore

Installation Kit

Model	Cascade No.	p/n
55F, 65F, 100F	205826	A000021227
120D, 150D, 165D	209555	A000032399
120D, 150D, 165D	223987	A000032400*

*For high pressure, up to 4,000 PSI.

D-Series

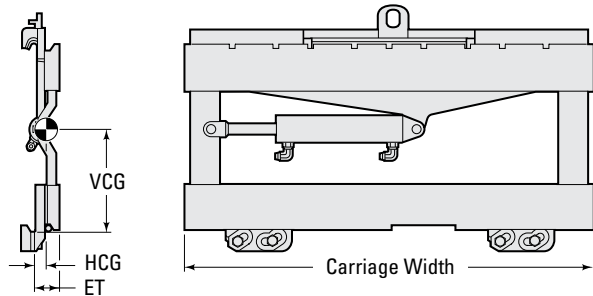

Mitsubishi Forklift Trucks F-Series

Capacity @ 24" (600 mm) Load Center		Carriage Width w/o Load Backrest	Cascade No.	p/n	Mtg. Class	Total Sideshift Available	Min. Truck Carriage Width	Weight		Effective Thickness	Horizontal Center of Gravity	Vertical Center of Gravity	# Backrest Holes/ Side	Load Backrest Type
lbs	kg							lbs	kg					
5,500	2,500	32.3"	55F-SSS-A093	A000032199	II	8"	28.9"	103	47	2.3"	1.1"	9.3"	4	A
5,500	2,500	32.3"	55F-SSS-A224	A000032223*	II	8"	28.9"	103	47	2.3"	1.1"	9.3"	2	A
5,500	2,500	36.2"	55F-SSS-A091	A000032197	II	8"	30.9"	110	50	2.3"	1.1"	9.2"	4	A
5,500	2,500	36.2"	55F-SSS-A222	A000032221*	II	8"	30.9"	110	50	2.3"	1.1"	9.2"	2	A
5,500	2,500	38.3"	55F-SSS-A035	A000032156	II	8"	35.2"	115	53	2.3"	1.1"	9.2"	2	B
5,500	2,500	39.4"	55F-SSS-A223	A000032222*	II	8"	35.2"	117	54	2.3"	1.1"	9.2"	2	A
5,500	2,500	39.4"	55F-SSS-A092	A000032198	II	8"	35.2"	117	54	2.3"	1.1"	9.2"	4	A
5,500	2,500	55.1"	55F-SSS-A225	A000032224*	II	8"	45.1"	177	81	2.3"	1.0"	8.6"	2	A
5,500	2,500	55.1"	55F-SSS-A094	A000032200	II	8"	45.1"	177	81	2.3"	1.0"	8.6"	4	A
6,500	3,000	37.8"	65F-SSS-B091	A000032268	III	8"	34.3"	144	66	2.5"	1.1"	11.7"	4	A
6,500	3,000	37.8"	65F-SSS-B159	A000032277	III	8"	34.3"	144	66	2.5"	1.1"	11.7"	2	A
6,500	3,000	37.8"	65F-SSS-B160	A000032278*	III	8"	34.3"	144	66	2.5"	1.1"	11.7"	2	A
6,500	3,000	39.4"	65F-SSS-B092	A000032269	III	8"	34.3"	148	68	2.5"	1.1"	11.7"	4	A
6,500	3,000	39.4"	65F-SSS-B161	A000032279*	III	8"	34.3"	148	68	2.5"	1.1"	11.7"	2	A
6,500	3,000	59.1"	65F-SSS-B090	A000032267	III	8"	47.8"	229	105	2.5"	1.1"	11.5"	4	A
6,500	3,000	59.1"	65F-SSS-B162	A000032280	III	8"	47.8"	229	105	2.5"	1.1"	11.5"	2	A
10,000	4,600	39.4"	100F-SSS-B200	A000032318*	III	8"	34.8"	244	111	3.0"	1.3"	12.4"	2	A
10,000	4,600	44.3"	100F-SSS-B201	A000032319*	III	8"	39.8"	268	122	3.0"	1.3"	12.4"	2	B
10,000	4,600	46.9"	100F-SSS-B203	A000032321*	III	8"	39.8"	279	127	3.0"	1.3"	12.4"	2	A
10,000	4,600	46.9"	100F-SSS-B093	A000032311	III	8"	39.8"	279	127	3.0"	1.3"	12.4"	4	A
10,000	4,600	54.0"	100F-SSS-B209	A000032325	III	8"	46.7"	317	144	3.0"	1.3"	12.4"	2	B
10,000	4,600	59.1"	100F-SSS-B204	A000032322*	III	8"	48.8"	372	169	3.0"	1.3"	12.2"	2	A
10,000	4,600	70.9"	100F-SSS-B205	A000032323*	III	8"	65.7"	480	218	3.0"	1.3"	12.0"	2	A

*Compatible with current OEM production.

F-Series

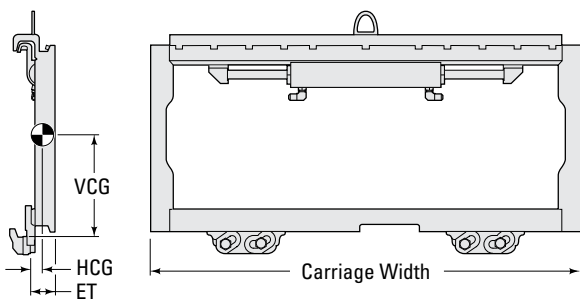

Load Backrest Types

- A: End hole patterns
- B: Face hole patterns
- C: Face hole patterns with counterbore

Installation Kit

Model	Cascade No.	p/n
55F, 65F, 100F	205826	A000021227

D-Series

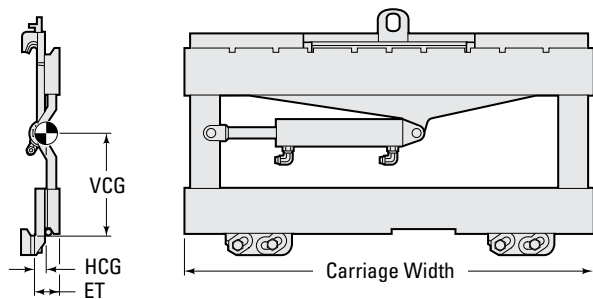

Mitsubishi Forklift Trucks D-Series

Capacity @ 24" (600 mm) Load Center		Carriage Width w/o Load Backrest	Cascade No.	p/n	Mtg. Class	Total Sideshift Available	Min. Truck Carriage Width	Weight		Effective Thickness	Horizontal Center of Gravity	Vertical Center of Gravity	# Backrest Holes/ Side	Load Backrest Type
lbs	kg							lbs	kg					
12,000	5,450	44.3"	120D-SSS-C125	A000032351*	IV	8"	42.1"	306	139	3.0"	1.3"	15.1"	2	B
12,000	5,450	46.9"	120D-SSS-C127	A000032353*	IV	8"	42.1"	339	154	3.0"	1.3"	15.1"	2	A
12,000	5,450	46.9"	120D-SSS-C122	A000032349	IV	8"	42.1"	339	154	3.0"	1.3"	15.1"	4	A
12,000	5,450	59.1"	120D-SSS-C123	A000032350	IV	8"	56.6"	392	178	3.0"	1.3"	15.1"	4	A
12,000	5,450	59.1"	120D-SSS-C128	A000032354*	IV	8"	56.6"	392	178	3.0"	1.3"	15.1"	2	A
12,000	5,450	60.0"	120D-SSS-C126	A000032352	IV	8"	56.6"	385	175	3.0"	1.3"	15.1"	2	B
12,000	5,450	70.9"	120D-SSS-C129	A000032355*	IV	8"	62.6"	491	223	3.0"	1.3"	15.1"	2	A
15,000	6,810	46.9"	150D-SSS-C017	A000032363	IV	12"	46.0"	491	223	3.3"	1.7"	17.4"	4	A
15,000	6,810	51.0"	150D-SSS-C110	A000032388*	IV	12"	48.0"	546	248	3.3"	1.7"	17.4"	2	B
15,000	6,810	59.1"	150D-SSS-C108	A000032386	IV	12"	48.0"	580	263	3.3"	1.7"	17.4"	4	A
15,000	6,810	70.9"	150D-SSS-C109	A000032387	IV	12"	60.0"	704	320	3.3"	1.7"	17.4"	4	A

*Compatible with current OEM production.

D-Series

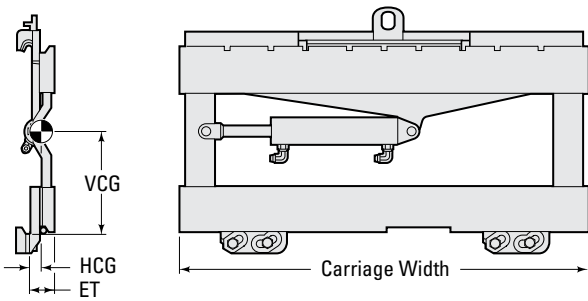

Load Backrest Types

- A: End hole patterns
- B: Face hole patterns
- C: Face hole patterns with counterbore

Installation Kit

Model	Cascade No.	p/n
120D, 150D, 165D	209555	A000032399
120D, 150D, 165D	223987	A000032400*

*For high pressure, up to 4,000 PSI.

Nissan F-Series

Capacity @ 24" (600 mm) Load Center		Carriage Width w/o Load Backrest	Cascade No.	p/n	Mtg. Class	Total Sideshift Available	Min. Truck Carriage Width	Weight		Effective Thickness	Horizontal Center of Gravity	Vertical Center of Gravity	# Backrest Holes/ Side	Load Backrest Type
lbs	kg							lbs	kg					
5,500	2,500	31.0"	55F-SSS-A056	A000032169	II	8"	28.9"	100	46	2.3"	1.1"	9.3"	2	A
5,500	2,500	32.4"	55F-SSS-A202	A000032217	II	8"	28.9"	103	47	2.3"	1.1"	9.3"	2	A
5,500	2,500	32.4"	55F-SSS-A470	A000032226*	II	8"	28.9"	103	47	2.3"	1.1"	9.2"	2	A
5,500	2,500	32.4"	55F-SSS-A074	A000032185	II	8"	28.9"	103	47	2.3"	1.1"	9.3"	4	A
5,500	2,500	36.2"	55F-SSS-A071	A000032182	II	8"	35.2"	110	50	2.3"	1.1"	9.2"	4	A
5,500	2,500	36.2"	55F-SSS-A203	A000032218	II	8"	35.2"	110	50	2.3"	1.1"	9.2"	2	A
5,500	2,500	36.2"	55F-SSS-A469	A000032225*	II	8"	35.2"	110	50	2.3"	1.1"	9.2"	2	A
5,500	2,500	36.2"	55F-SSS-A177	A000032211	II	8"	35.2"	110	50	2.3"	1.1"	9.2"	2	A
5,500	2,500	37.0"	55F-SSS-A051	A000032166	II	8"	35.2"	112	51	2.3"	1.1"	9.2"	2	A
5,500	2,500	40.2"	55F-SSS-A073	A000032184	II	8"	35.2"	118	54	2.3"	1.1"	9.2"	4	A
5,500	2,500	40.2"	55F-SSS-A204	A000032219	II	8"	35.2"	118	54	2.3"	1.1"	9.2"	2	A
5,500	2,500	40.2"	55F-SSS-A471	A000032227*	II	8"	35.2"	118	54	2.3"	1.1"	9.2"	2	A
5,500	2,500	40.2"	55F-SSS-A178	A000032212	II	8"	35.2"	118	54	2.3"	1.1"	9.2"	2	A
5,500	2,500	41.0"	55F-SSS-A052	A000032167	II	8"	35.2"	120	55	2.3"	1.1"	9.1"	2	A
5,500	2,500	49.0"	55F-SSS-A054	A000032168	II	8"	40.9"	146	67	2.3"	1.1"	8.9"	2	A
5,500	2,500	52.6"	55F-SSS-A205	A000032220	II	8"	45.1"	172	79	2.3"	1.0"	8.6"	2	A
5,500	2,500	52.6"	55F-SSS-A072	A000032183	II	8"	45.1"	172	79	2.3"	1.0"	8.6"	4	A
5,500	2,500	52.6"	55F-SSS-A472	A000032228*	II	8"	45.1"	172	79	2.3"	1.0"	8.6"	4	A

*Compatible with current OEM production.

F-Series

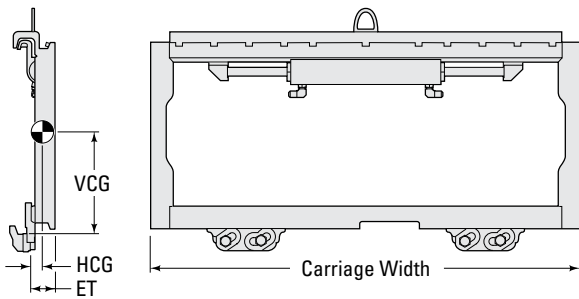

Load Backrest Types

- A: End hole patterns
- B: Face hole patterns
- C: Face hole patterns with counterbore

Installation Kit

Model	Cascade No.	p/n
55F, 65F, 100F	205826	A000021227

Nissan F-Series and D-Series

Capacity @ 24" (600 mm) Load Center		Carriage Width w/o Load Backrest	Cascade No.	p/n	Mtg. Class	Total Sideshift Available	Min. Truck Carriage Width	Weight		Effective Thickness	Horizontal Center of Gravity	Vertical Center of Gravity	# Backrest Holes/ Side	Load Backrest Type
lbs	kg							lbs	kg					
6,500	3,000	37.0"	65F-SSS-B051	A000032247	III	8"	34.3"	141	65	2.5"	1.1"	11.6"	2	A
6,500	3,000	38.6"	65F-SSS-B071	A000032257	III	8"	34.3"	146	67	2.5"	1.1"	11.7"	4	A
6,500	3,000	40.1"	65F-SSS-B068	A000032254	III	8"	34.3"	150	68	2.5"	1.1"	11.7"	2	A
6,500	3,000	40.2"	65F-SSS-B069	A000032255	III	8"	34.3"	150	69	2.5"	1.1"	11.7"	4	A
6,500	3,000	40.2"	65F-SSS-B137	A000032274*	III	8"	34.3"	150	69	2.5"	1.1"	11.7"	2	A
6,500	3,000	40.2"	65F-SSS-B138	A000032275	III	8"	34.3"	150	69	2.5"	1.1"	11.7"	2	A
6,500	3,000	40.9"	65F-SSS-B052	A000032248	III	8"	36.8"	152	70	2.5"	1.1"	11.7"	2	A
6,500	3,000	49.0"	65F-SSS-B053	A000032249	III	8"	40.7"	172	79	2.5"	1.1"	11.8"	2	A
6,500	3,000	52.6"	65F-SSS-B070	A000032256	III	8"	40.7"	213	97	2.5"	1.1"	11.3"	4	A
6,500	3,000	52.6"	65F-SSS-B139	A000032276	III	8"	40.7"	213	97	2.5"	1.1"	11.3"	2	A
6,500	3,000	61.0"	65F-SSS-B054	A000032250	III	8"	47.8"	234	107	2.5"	1.1"	11.5"	2	A
10,000	4,600	40.2"	100F-SSS-B068	A000032304*	III	8"	36.8"	249	113	3.0"	1.3"	12.4"	2	A
10,000	4,600	47.2"	100F-SSS-B073	A000032306	III	8"	41.9"	282	128	3.0"	1.3"	12.4"	4	A
10,000	4,600	70.9"	100F-SSS-B071	A000032305	III	8"	65.7"	480	218	3.0"	1.3"	12.0"	4	A
15,000	6,810	59.0"	150D-SSS-C071	A000032374	IV	12"	48.0"	580	263	3.3"	1.7"	17.4"	4	A
15,000	6,810	74.8"	150D-SSS-C072	A000032375	IV	12"	72.0"	725	329	3.3"	1.7"	17.4"	4	A

*Compatible with current OEM production.

F-Series

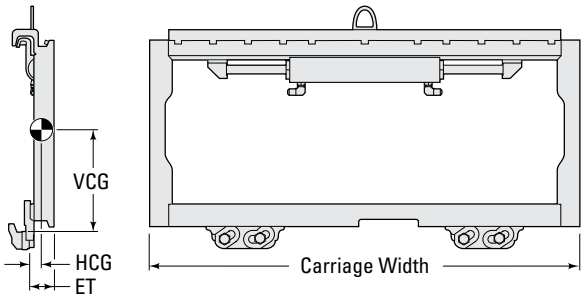

D-Series

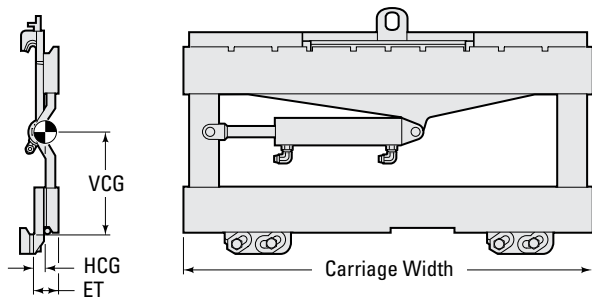

Load Backrest Types

- A: End hole patterns
- B: Face hole patterns
- C: Face hole patterns with counterbore

Installation Kit

Model	Cascade No.	p/n
55F, 65F, 100F	205826	A000021227
120D, 150D, 165D	209555	A000032399
120D, 150D, 165D	223987	A000032400*

*For high pressure, up to 4,000 PSI.

Raymond F-Series and Narrow Aisle

Capacity @ 24" (600 mm) Load Center		Carriage Width w/o Load Backrest	Cascade No.	p/n	Mtg. Class	Total Sideshift Available	Min. Truck Carriage Width	Weight		Effective Thickness	Horizontal Center of Gravity	Vertical Center of Gravity	# Backrest Holes/Side	Load Backrest Type
lbs	kg							lbs	kg					
4,500	2,045	32.0"	55F-SSS-A067	A000032179*	II	4"	28.9"	102	47	2.3"	1.1"	9.3"	2	C
4,500	2,045	32.0"	55F-SSS-A068	A000032180*	II	8"	28.9"	102	47	2.3"	1.1"	9.3"	2	C
5,500	2,500	32.0"	55F-SSS-A065	A000032178	II	8"	26.2"	102	47	2.3"	1.1"	9.3"	2	A
5,500	2,500	36.0"	55F-SSS-A069	A000032181	II	8"	35.2"	110	50	2.3"	1.1"	9.2"	2	A
5,500	2,500	37.0"	55F-SSS-A160	A000032210	II	8"	35.2"	112	51	2.3"	1.1"	9.2"	2	A

*Narrow Aisle model with straddle leg cutouts.

F-Series

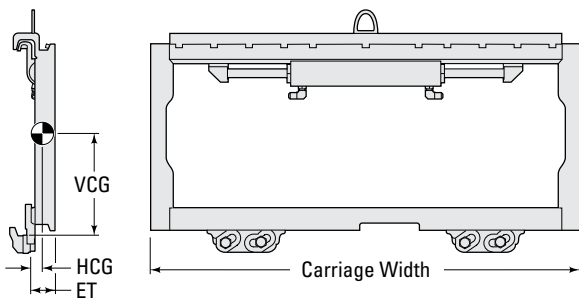

Load Backrest Types

- A: End hole patterns
- B: Face hole patterns
- C: Face hole patterns with counterbore

Installation Kit

Model	Cascade No.	p/n
55F, 65F, 100F	205826	A000021227

Narrow Aisle Sideshifter

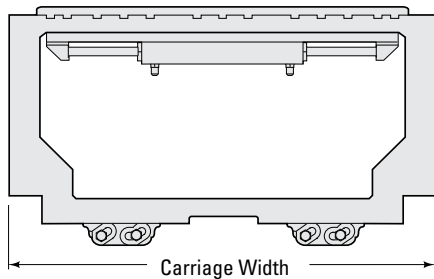

TCM F-Series and D-Series

Capacity @ 24" (600 mm) Load Center		Carriage Width w/o Load Backrest	Cascade No.	p/n	Mtg. Class	Total Sideshift Available	Min. Truck Carriage Width	Weight		Effective Thickness	Horizontal Center of Gravity	Vertical Center of Gravity	# Backrest Holes/ Side	Load Backrest Type
lbs	kg							lbs	kg					
5,500	2,500	32.6"	55F-SSS-A083	A000032190*	II	8"	30.8"	103	47	2.3"	1.1"	9.3"	4	A
5,500	2,500	36.6"	55F-SSS-A082	A000032189*	II	8"	35.2"	111	51	2.3"	1.1"	9.2"	4	A
5,500	2,500	38.1"	55F-SSS-A084	A000032191*	II	8"	35.2"	114	52	2.3"	1.1"	9.1"	4	A
5,500	2,500	40.9"	55F-SSS-A081	A000032188*	II	8"	35.2"	120	55	2.3"	1.1"	9.2"	4	A
6,500	3,000	40.9"	65F-SSS-B098	A000032270*	III	8"	36.8"	152	70	2.5"	1.1"	11.7"	4	A
6,500	3,000	43.3"	65F-SSS-B081	A000032261*	III	8"	36.8"	142	65	2.5"	1.1"	11.7"	4	A
6,500	3,000	61.4"	65F-SSS-B084	A000032262*	III	8"	53.9"	236	108	2.5"	1.1"	11.5"	4	A
10,000	4,600	43.3"	100F-SSS-B081	A000032307*	III	8"	36.8"	262	119	3.0"	1.3"	12.4"	4	A
10,000	4,600	47.6"	100F-SSS-B082	A000032308*	III	8"	41.9"	282	128	3.0"	1.3"	12.4"	4	A
10,000	4,600	51.2"	100F-SSS-B084	A000032309	III	8"	46.7"	299	136	3.0"	1.3"	12.4"	4	A
10,000	4,600	51.2"	100F-SSS-B218	A000032326*	III	8"	46.7"	299	136	3.0"	1.3"	12.4"	4	A
10,000	4,600	66.9"	100F-SSS-B085	A000032310	III	8"	57.9"	440	200	3.0"	1.3"	12.0"	4	A
10,000	4,600	71.3"	100F-SSS-B219	A000032327*	III	8"	65.7"	480	218	3.0"	1.3"	12.0"	4	A
12,000	5,450	51.2"	120D-SSS-C082	A000032347*	IV	8"	51.2"	363	164	3.0"	1.57"	14.8"	4	A
12,000	5,450	71.3"	120D-SSS-C083	A000032348*	IV	8"	71.3"	498	226	3.0"	1.57"	14.8"	4	A
15,000	6,810	72.6"	150D-SSS-C082	A000032378*	IV	12"	60.0"	710	322	3.3"	1.70"	17.4"	4	A
16,500	7,490	79.3"	165D-SSS-C084	A000032395*	IV	12"	79.3"	786	356	3.5"	1.93"	14.7"	4	A

*Compatible with current OEM production.

F-Series

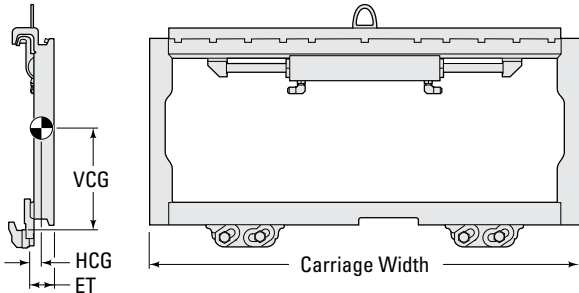

D-Series

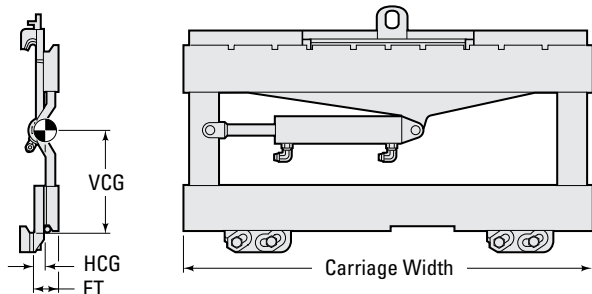

Load Backrest Types

- A: End hole patterns
- B: Face hole patterns
- C: Face hole patterns with counterbore

Installation Kit

Model	Cascade No.	p/n
55F, 65F, 100F	205826	A000021227
120D, 150D, 165D	209555	A000032399
120D, 150D, 165D	223987	A000032400*

*For high pressure, up to 4,000 PSI.

Toyota F-Series and D-Series

Capacity @ 24" (600 mm) Load Center		Carriage Width w/o Load Backrest	Cascade No.	p/n	Mtg. Class	Total Sideshift Available	Min. Truck Carriage Width	Weight		Effective Thickness	Horizontal Center of Gravity	Vertical Center of Gravity	# Backrest Holes/ Side	Load Backrest Type
lbs	kg							lbs	kg					
5,500	2,500	31.9"	55F-SSS-A011	A000032142*	II	8"	28.9"	102	47	2.3"	1.1"	9.2"	2	A
5,500	2,500	32.3"	55F-SSS-A110	A000032202	II	8"	28.9"	103	47	2.3"	1.1"	9.3"	2	A
5,500	2,500	36.2"	55F-SSS-A087	A000032194*	II	8"	30.9"	110	50	2.3"	1.1"	9.2"	2	A
5,500	2,500	37.0"	55F-SSS-A085	A000032192	II	8"	35.2"	112	51	2.3"	1.1"	9.2"	5	A
5,500	2,500	38.2"	55F-SSS-A090	A000032196	II	8"	35.2"	114	52	2.3"	1.1"	9.1"	5	A
5,500	2,500	40.2"	55F-SSS-A086	A000032193*	II	8"	35.2"	118	54	2.3"	1.1"	9.2"	2	A
5,500	2,500	46.1"	55F-SSS-A012	A000032143*	II	8"	40.9"	130	60	2.3"	1.1"	9.1"	2	A
5,500	2,500	52.0"	55F-SSS-A089	A000032195*	II	8"	45.1"	171	78	2.3"	1.0"	8.6"	2	A
5,500	2,500	57.9"	55F-SSS-A010	A000032141*	II	8"	48.8"	196	90	2.3"	1.0"	8.5"	2	A
6,500	3,000	38.2"	65F-SSS-B087	A000032264*	III	8"	34.3"	145	67	2.5"	1.1"	11.7"	2	A
6,500	3,000	42.1"	65F-SSS-B086	A000032263*	III	8"	36.8"	155	71	2.5"	1.1"	11.7"	2	A
6,500	3,000	46.1"	65F-SSS-B089	A000032266*	III	8"	40.7"	165	75	2.5"	1.1"	11.8"	2	A
6,500	3,000	52.0"	65F-SSS-B101	A000032271*	III	8"	40.7"	211	96	2.5"	1.1"	11.3"	2	A
6,500	3,000	57.9"	65F-SSS-B088	A000032265*	III	8"	47.8"	227	103	2.5"	1.1"	11.5"	2	A
10,000	4,600	42.9"	100F-SSS-B141	A000032313*	III	8"	36.8"	262	116	3.0"	1.3"	12.4"	2	A
10,000	4,600	46.1"	100F-SSS-B140	A000032312*	III	8"	39.8"	275	125	3.0"	1.3"	12.4"	2	A
10,000	4,600	57.9"	100F-SSS-B143	A000032315*	III	8"	48.8"	367	167	3.0"	1.3"	12.2"	2	A
10,000	4,600	64.2"	100F-SSS-B142	A000032314*	III	8"	57.9"	429	195	3.0"	1.3"	12.0"	2	A
12,000	5,450	46.1"	120D-SSS-C032	A000032338	IV	8"	42.1"	337	153	3.0"	1.3"	15.1"	4	A
12,000	5,450	46.1"	120D-SSS-C033	A000032339*	IV	8"	42.0"	339	154	3.0"	1.3"	15.1"	2	A
12,000	5,450	66.9"	120D-SSS-C035	A000032340*	IV	8"	62.9"	475	216	3.0"	1.3"	15.1"	2	A
12,000	5,450	66.9"	120D-SSS-C031	A000032337	IV	8"	62.9"	475	216	3.0"	1.3"	15.1"	4	A
15,000	6,810	46.1"	150D-SSS-C086	A000032380	IV	12"	46.1"	488	222	3.3"	1.7"	17.4"	4	A
15,000	6,810	46.1"	150D-SSS-C087	A000032381*	IV	12"	42.0"	488	222	3.3"	1.7"	17.4"	2	A
15,000	6,810	66.9"	150D-SSS-C085	A000032379	IV	12"	60.0"	675	306	3.3"	1.7"	17.4"	4	A
15,000	6,810	66.9"	150D-SSS-C089	A000032382*	IV	12"	60.0"	675	306	3.3"	1.7"	17.4"	2	A
15,000	6,810	67.7"	150D-SSS-C098	A000032383	IV	12"	59.0"	680	309	3.3"	1.7"	17.4"	4	A
15,000	6,810	72.0"	150D-SSS-C099	A000032384	IV	12"	60.0"	704	320	3.3"	1.7"	17.4"	4	A
15,000	6,810	91.7"	150D-SSS-C100	A000032385	IV	12"	82.0"	830	377	3.3"	1.7"	17.4"	4	A
16,500	7,490	66.9"	165D-SSS-C089	A000032396*	IV	12"	66.9"	675	306	3.3"	1.7"	17.4"	2	A

*Compatible with current OEM production. For multi-drilled units for all series, please contact Promatch dealer support.

F-Series

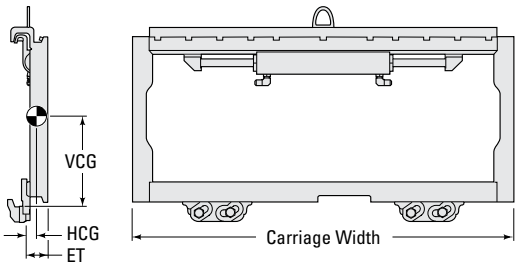

D-Series

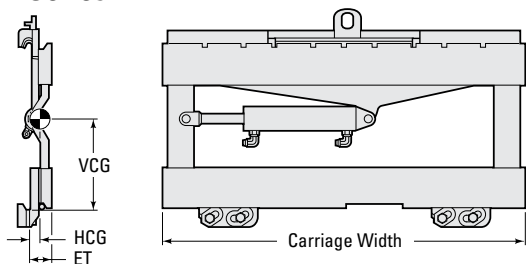

Load Backrest Types

- A: End hole patterns
- B: Face hole patterns
- C: Face hole patterns with counterbore

Installation Kit

Model	Cascade No.	p/n
55F, 65F, 100F	205826	A000021227
120D, 150D, 165D	209555	A000032399
120D, 150D, 165D	223987	A000032400*

*For high pressure, up to 4,000 PSI.

TUSK F-Series and D-Series

Capacity @ 24" (600 mm) Load Center		Carriage Width w/o Load Backrest	Cascade No.	p/n	Mtg. Class	Total Sideshift Available	Min. Truck Carriage Width	Weight		Effective Thickness	Horizontal Center of Gravity	Vertical Center of Gravity	# Backrest Holes/Side	Load Backrest Type
lbs	kg							lbs	kg					
5,500	2,500	31.0"	55F-SSS-A056	A000032169	II	8"	28.9"	100	46	2.3"	1.1"	9.3"	2	A
5,500	2,500	34.0"	55F-SSS-A027	A000032151	II	8"	30.9"	106	48	2.3"	1.1"	9.3"	1	B
5,500	2,500	37.0"	55F-SSS-A051	A000032166	II	8"	35.2"	112	51	2.3"	1.1"	9.2"	2	A
5,500	2,500	38.0"	55F-SSS-A022	A000032147	II	8"	35.2"	114	51	2.3"	1.1"	9.1"	1	B
5,500	2,500	38.2"	55F-SSS-A077	A000032186	II	8"	35.2"	114	52	2.3"	1.1"	9.1"	4	A
5,500	2,500	41.0"	55F-SSS-A052	A000032167	II	8"	35.2"	120	55	2.3"	1.1"	9.1"	2	A
5,500	2,500	42.0"	55F-SSS-A023	A000032148	II	8"	38.4"	122	55	2.3"	1.1"	9.2"	1	B
5,500	2,500	48.0"	55F-SSS-A024	A000032149	II	8"	40.9"	134	60	2.3"	1.1"	9.1"	1	B
5,500	2,500	49.0"	55F-SSS-A054	A000032168	II	8"	40.9"	135	61	2.3"	1.1"	9.1"	1	A
5,500	2,500	53.0"	55F-SSS-A079	A000032187	II	8"	40.9"	172	79	2.3"	1.0"	8.5"	2	A
5,500	2,500	54.0"	55F-SSS-A025	A000032150	II	8"	45.1"	180	79	2.3"	1.0"	8.5"	2	A
5,500	2,500	61.0"	55F-SSS-A057	A000032170	II	8"	51.9"	203	93	2.3"	1.0"	8.5"	2	A
6,500	3,000	37.0"	65F-SSS-B051	A000032247	III	8"	34.3"	141	65	2.5"	1.1"	11.6"	2	A
6,500	3,000	37.8"	65F-SSS-B075	A000032258	III	8"	34.3"	144	66	2.5"	1.1"	11.7"	2	A
6,500	3,000	38.0"	65F-SSS-B021	A000032235	III	8"	34.3"	145	66	2.5"	1.1"	11.7"	1	C
6,500	3,000	40.9"	65F-SSS-B052	A000032248	III	8"	36.8"	152	70	2.5"	1.1"	11.7"	2	A
6,500	3,000	41.7"	65F-SSS-B079	A000032260	III	8"	36.8"	154	71	2.5"	1.1"	11.7"	4	A
6,500	3,000	42.0"	65F-SSS-B022	A000032236	III	8"	36.8"	155	70	2.5"	1.1"	11.7"	1	C
6,500	3,000	48.0"	65F-SSS-B023	A000032237	III	8"	40.7"	170	77	2.5"	1.1"	11.8"	1	C
6,500	3,000	49.0"	65F-SSS-B053	A000032249	III	8"	40.7"	172	79	2.5"	1.1"	11.8"	2	A
6,500	3,000	53.0"	65F-SSS-B078	A000032259	III	8"	40.7"	214	98	2.5"	1.1"	11.4"	2	A
6,500	3,000	61.0"	65F-SSS-B054	A000032250	III	8"	47.8"	234	107	2.5"	1.1"	11.5"	2	A
10,000	4,600	46.9"	100F-SSS-B061	A000032302	III	8"	39.8"	279	127	3.0"	1.3"	12.4"	4	A
10,000	4,600	68.1"	100F-SSS-B063	A000032303	III	8"	57.9"	447	203	3.0"	1.3"	12.0"	4	A
12,000	5,450	46.8"	120D-SSS-C067	A000032344	IV	8"	42.1"	338	154	3.0"	1.3"	15.1"	4	A
12,000	5,450	68.1"	120D-SSS-C068	A000032345	IV	8"	62.9"	476	216	3.0"	1.3"	15.1"	4	A
15,000	6,810	67.7"	150D-SSS-C076	A000032377	IV	12"	59.0"	680	309	3.3"	1.7"	17.4"	4	A
15,000	6,810	67.7"	150D-SSS-C098	A000032383	IV	12"	59.0"	680	309	3.3"	1.7"	17.4"	4	A
15,000	6,810	72.0"	150D-SSS-C099	A000032384	IV	12"	60.0"	704	320	3.3"	1.7"	17.4"	4	A
15,000	6,810	91.7"	150D-SSS-C100	A000032385	IV	12"	82.0"	830	377	3.3"	1.7"	17.4"	4	A

F-Series

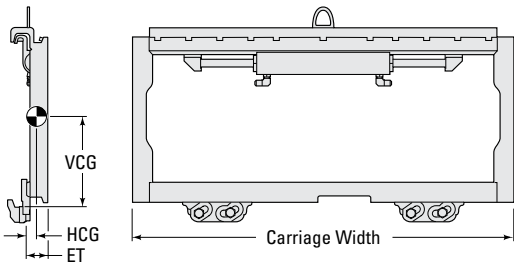

D-Series

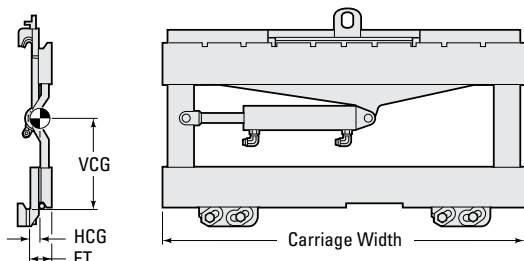

Load Backrest Types

- A: End hole patterns
- B: Face hole patterns
- C: Face hole patterns with counterbore

Installation Kit

Model	Cascade No.	p/n
55F, 65F, 100F	205826	A000021227
120D, 150D, 165D	209555	A000032399
120D, 150D, 165D	223987	A000032400*

*For high pressure, up to 4,000 PSI.

Yale F-Series

Capacity @ 24" (600 mm) Load Center		Carriage Width w/o Load Backrest	Cascade No.	p/n	Mtg. Class	Total Sideshift Available	Min. Truck Carriage Width	Weight		Effective Thickness	Horizontal Center of Gravity	Vertical Center of Gravity	# Backrest Holes/ Side	Load Backrest Type
lbs	kg							lbs	kg					
5,500	2,500	32.5"	55F-SSS-A043	A000032162	II	8"	28.9"	103	47	2.3"	1.1"	9.3"	2	A
5,500	2,500	33.7"	55F-SSS-A007	A000032138	II	8"	28.9"	105	48	2.3"	1.1"	9.2"	2	C
5,500	2,500	35.7"	55F-SSS-A045	A000032164	II	8"	35.2"	109	50	2.3"	1.1"	9.2"	2	C
5,500	2,500	38.0"	55F-SSS-A008	A000032139	II	8"	35.2"	114	52	2.3"	1.1"	9.2"	2	B
5,500	2,500	38.5"	55F-SSS-A030	A000032153	II	8"	35.2"	115	53	2.3"	1.1"	9.2"	2	C
5,500	2,500	38.5"	55F-SSS-A044	A000032163	II	8"	35.2"	115	53	2.3"	1.1"	9.2"	2	A
5,500	2,500	39.0"	55F-SSS-A041	A000032160	II	8"	35.2"	116	54	2.3"	1.1"	9.2"	2	A
5,500	2,500	42.0"	55F-SSS-A009	A000032140	II	8"	38.4"	122	56	2.3"	1.1"	9.2"	2	C
5,500	2,500	42.0"	55F-SSS-A042	A000032161	II	8"	38.4"	122	56	2.3"	1.1"	9.2"	2	A
5,500	2,500	42.0"	55F-SSS-A141	A000032205	II	8"	38.3"	122	56	2.3"	1.1"	9.2"	2	A
6,500	3,000	38.5"	65F-SSS-B003	A000032231	III	8"	34.3"	146	47	2.5"	1.1"	11.7"	2	B
6,500	3,000	38.8"	65F-SSS-B044	A000032245	III	8"	34.3"	146	67	2.5"	1.1"	11.7"	2	A
6,500	3,000	39.0"	65F-SSS-B041	A000032242	III	8"	34.3"	147	67	2.5"	1.1"	11.7"	2	A
6,500	3,000	42.0"	65F-SSS-B042	A000032243	III	8"	36.8"	154	70	2.5"	1.1"	11.7"	2	A
6,500	3,000	42.0"	65F-SSS-B002	A000032230	III	8"	36.8"	154	70	2.5"	1.1"	11.7"	2	B
6,500	3,000	48.0"	65F-SSS-B043	A000032244	III	8"	40.7"	169	77	2.5"	1.1"	11.8"	2	A
10,000	4,600	42.0"	100F-SSS-B042	A000032294	III	8"	36.8"	257	117	3.0"	1.3"	12.4"	2	A
10,000	4,600	42.0"	100F-SSS-B001	A000032281	III	8"	36.8"	257	117	3.0"	1.3"	12.4"	2	B
10,000	4,600	47.3"	100F-SSS-B006	A000032284	III	8"	41.9"	282	128	3.0"	1.3"	12.4"	2	B
10,000	4,600	48.0"	100F-SSS-B002	A000032282	III	8"	41.9"	284	129	3.0"	1.3"	12.4"	2	B
10,000	4,600	48.0"	100F-SSS-B044	A000032296	III	8"	41.9"	284	129	3.0"	1.3"	12.4"	2	A
10,000	4,600	53.3"	100F-SSS-B007	A000032285	III	8"	46.7"	312	142	3.0"	1.3"	12.4"	2	B
10,000	4,600	54.0"	100F-SSS-B043	A000032295	III	8"	46.7"	317	144	3.0"	1.3"	12.4"	2	A
10,000	4,600	60.0"	100F-SSS-B003	A000032283	III	8"	48.8"	376	171	3.0"	1.3"	12.2"	2	B

F-Series

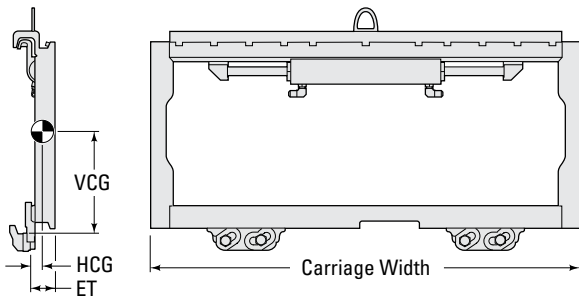

Load Backrest Types

- A: End hole patterns
- B: Face hole patterns
- C: Face hole patterns with counterbore

Installation Kit

Model	Cascade No.	p/n
55F, 65F, 100F	205826	A000021227

For ORFS kits please contact Promatch dealer support.

Yale D-Series

Capacity @ 24" (600 mm) Load Center		Carriage Width w/o Load Backrest	Cascade No.	p/n	Mtg. Class	Total Sideshift Available	Min. Truck Carriage Width	Weight		Effective Thickness	Horizontal Center of Gravity	Vertical Center of Gravity	# Backrest Holes/ Side	Load Backrest Type
lbs	kg							lbs	kg					
12,000	5,450	42.0"	120D-SSS-C021	A000032330	IV	8"	42.1"	319	145	3.0"	1.3"	15.1"	2	B
12,000	5,450	47.3"	120D-SSS-C018	A000032329	IV	8"	42.0"	345	157	3.0"	1.3"	15.1"	2	B
12,000	5,450	48.0"	120D-SSS-C022	A000032331	IV	8"	42.1"	345	157	3.0"	1.3"	15.1"	2	B
12,000	5,450	48.0"	120D-SSS-C026	A000032334	IV	8"	42.1"	345	157	3.0"	1.3"	15.1"	2	A
12,000	5,450	54.0"	120D-SSS-C027	A000032335	IV	8"	50.9"	370	168	3.0"	1.3"	15.1"	2	A
12,000	5,450	60.0"	120D-SSS-C028	A000032336	IV	8"	56.6"	396	180	3.0"	1.3"	15.1"	2	A
15,000	6,810	42.0"	150D-SSS-C025	A000032365*	IV	8"	42.0"	453	205	3.3"	1.9"	14.7"	2	C
15,000	6,810	48.0"	150D-SSS-C024	A000032364*	IV	12"	46.0"	490	222	3.3"	1.9"	14.7"	2	C
15,000	6,810	48.0"	150D-SSS-C002	A000032357	IV	12"	46.0"	506	230	3.3"	1.7"	17.4"	2	B
15,000	6,810	60.0"	150D-SSS-C026	A000032366*	IV	12"	48.0"	564	255	3.3"	1.9"	14.7"	2	C
15,000	6,810	60.0"	150D-SSS-C043	A000032369	IV	12"	48.0"	590	268	3.3"	1.7"	17.4"	2	A
15,000	6,810	78.0"	150D-SSS-C004	A000032359*	IV	12"	78.0"***	781	354	3.4"	1.8"	14.3"	3	A

*Compatible with current OEM production.

**If host carriage has no end bars, 72" minimum truck carriage width is available.

D-Series

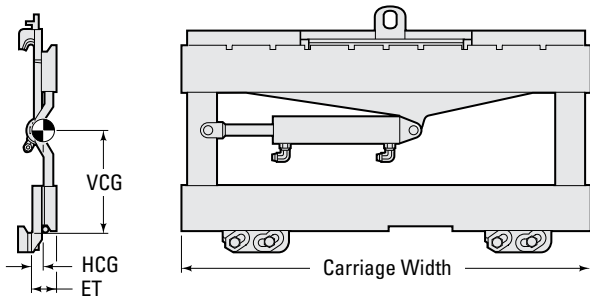

Load Backrest Types

- A: End hole patterns
- B: Face hole patterns
- C: Face hole patterns with counterbore

Installation Kit

Model	Catalog No.	p/n
120D, 150D, 165D	209555	A000032399
120D, 150D, 165D	223987	A000032400*

*For high pressure, up to 4,000 PSI.

Doosan/Hyundai/Landoll/Schaeff/Tailift F-Series

Capacity @ 24" (600 mm) Load Center		Carriage Width w/o Load Backrest	Cascade No.	p/n	Mtg. Class	Total Sideshift Available	Min. Truck Carriage Width	Weight		Effective Thickness	Horizontal Center of Gravity	Vertical Center of Gravity	# Backrest Holes/Side	Load Backrest Type
lbs	kg							lbs	kg					
Doosan														
5,500	2,500	35.9"	55F-SSS-A040	A000032159	II	8"	35.2"	110	50	2.3"	1.1"	9.2"	2	B
5,500	2,500	38.3"	55F-SSS-A033	A000032154	II	8"	35.2"	115	53	2.3"	1.1"	9.2"	2	B
5,500	2,500	43.4"	55F-SSS-A034	A000032155	II	8"	38.3"	125	57	2.3"	1.1"	9.1"	2	B
5,500	2,500	56.7"	55F-SSS-A038	A000032158	II	8"	48.8"	181	83	2.3"	1.1"	8.6"	2	B
6,500	3,000	40.4"	65F-SSS-B026	A000032238	III	8"	34.3"	150	69	2.5"	1.1"	11.7"	2	B
6,500	3,000	43.9"	65F-SSS-B027	A000032239	III	8"	36.8"	159	73	2.5"	1.1"	11.7"	2	B
10,000	4,600	47.8"	100F-SSS-B032	A000032292	III	8"	40.7"	335	153	3.0"	1.3"	12.4"	2	B
10,000	4,600	61.6"	100F-SSS-B035	A000032293	III	8"	47.7"	439	200	3.0"	1.6"	11.5"	2	B
Hyundai														
5,500	2,500	40.2"	55F-SSS-A102	A000032201	II	8"	35.2"	118	54	2.3"	1.1"	9.2"	2	A
6,500	3,000	41.7"	65F-SSS-B127	A000032273	III	8"	36.8"	154	71	2.5"	1.1"	11.7"	4	A
6,500	3,000	41.7"	65F-SSS-B046	A000032246	III	8"	36.8"	154	71	2.5"	1.1"	11.7"	2	A
10,000	4,600	51.2"	100F-SSS-B152	A000032316	III	8"	46.7"	299	136	3.0"	1.3"	12.4"	2	A
10,000	4,600	63.0"	100F-SSS-B153	A000032317	III	8"	57.9"	392	178	3.0"	1.3"	12.2"	2	A
Landoll														
4,000	1,815	37.0"	55F-SSS-A147	A000032207*	II	11.7"	31.0"	118	54	2.3"	1.1"	9.0"	2	A
5,500	2,500	31.0"	55F-SSS-A149	A000032209	II	8"	28.9"	100	46	2.3"	1.1"	9.0"	2	A
5,500	2,500	37.0"	55F-SSS-A148	A000032208	II	8"	31.0"	118	54	2.3"	1.1"	9.0"	2	A
5,500	2,500	37.0"	55F-SSS-A146	A000032206*	II	11.7"	35.2"	118	54	2.3"	1.1"	9.0"	2	A
Schaeff														
5,500	2,500	37.5"	55F-SSS-A028	A000032152	II	8"	35.2"	113	51	2.3"	1.1"	9.2"	2	A
5,500	2,500	39.0"	55F-SSS-A047	A000032165	II	8"	35.2"	116	53	2.3"	1.1"	9.2"	2	A
Tailift														
5,500	2,500	36.3"	55F-SSS-A135	A000032203	II	8"	35.2"	110	50	2.3"	1.1"	9.2"	2	A
5,500	2,500	40.2"	55F-SSS-A136	A000032204	II	8"	35.2"	118	54	2.3"	1.1"	9.2"	2	A
6,500	3,000	45.3"	65F-SSS-B110	A000032272	III	8"	40.7"	163	75	2.5"	1.1"	11.8"	4	A

F-Series

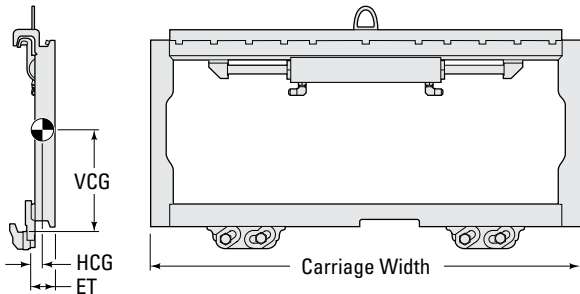

Load Backrest Types

- A: End hole patterns
- B: Face hole patterns
- C: Face hole patterns with counterbore

Installation Kit

Model	Cascade No.	p/n
Doosan	223311	A000032397
Landoll	6000708	A000032398
Hyundai, Schaeff, Tailift	205826	A000021227

*Lateral CG at Max Sideshift (per ASME B56.1-2000)

Cascade No.	p/n	Lateral CG from centerline at Max SS	Maximum sideshift from centerline
55F-SSS-A146	A000032207	5.6"	5.9"
55F-SSS-A147	A000032206	5.6"	5.9"

This applies to models that exceed the 8.0" sideshift stroke.